

Teacher Information

3-2-1 POP!

Objective:

To demonstrate how rocket liftoff is an application of Newton's Laws of Motion.

Description:

Students construct a rocket powered by the pressure generated from an effervescent antacid tablet reacting with water.

Science Standards:

Physical Science - Position and motion of objects
Science and Technology - Abilities of technological design - Understanding about science and technology

Process Skills:

Observing
Communicating
Making Models
Inferring

Management:

For best results, students should work in pairs. It will take approximately 40 to 45 minutes to complete the activity. Make samples of rockets in various stages of completion available for students to study. This will help some students visualize the construction steps.

A single sheet of paper is sufficient to make a rocket. Be sure to tell the students to plan how they are going to use the paper. Let the students decide whether to cut the paper the short or long direction to make the body tube of the rocket. This will lead to rockets of different lengths for flight comparison.

The most common mistakes in constructing the rocket are: forgetting to tape the film canister to the rocket body, failing to mount the canister with the lid end down, and not extending the canister far enough from the paper tube to make snapping the lid easy. Some students may have difficulty in forming the cone. To make a cone, cut out a "Pacman" shape from a circle and curl it into a cone. See the pattern on the next page. Cones can be any size.

Materials and Tools:

- Heavy paper (60-110 index stock or construction paper)
 - Plastic 35 mm film canister*
 - Student sheets
 - Cellophane tape
 - Scissors
 - Effervescent antacid tablet
 - Paper towels
 - Water
 - Eye protection
- * The film canister must have an internal-sealing lid. See management section for more details.



Film canisters are available from camera shops and stores where photographic processing takes place. These businesses recycle the canisters and are often willing to donate them for educational use. Be sure to obtain canisters with the internal sealing lid. These are usually translucent canisters. Canisters with the external lid (lid that wraps around the canister rim) will not work. These are usually opaque canisters.

Background Information:

This activity is a simple but exciting demonstration of Newton's Laws of Motion. The rocket lifts off because it is acted upon by an unbalanced force (First Law). This is the force produced when the lid blows off by the gas formed in the canister. The rocket travels upward with a force that is equal and opposite to the downward force propelling the water, gas, and lid (Third Law). The amount of force is directly proportional to the mass of water and gas expelled from the canister and how fast it accelerates (Second Law). For a more complete discussion of Newton's Laws of Motion, see pages 13-17 in this guide.

Procedure:

Refer to the Student Sheet.

Discussion:

- How does the amount of water placed in the cylinder affect how high the rocket will fly?
- How does the temperature of the water affect how high the rocket will fly?
- How does the amount of the tablet used affect how high the rocket will fly?
- How does the length or empty weight of the rocket affect how high the rocket will fly?
- How would it be possible to create a two-stage rocket?

Assessment:

Ask students to explain how Newton's Laws of Motion apply to this rocket. Compare the rockets for skill in construction. Rockets that use excessive paper and tape are likely to be less efficient fliers because they carry additional weight.

Extensions:

- Hold an altitude contest to see which rockets fly the highest. Launch the rockets near a wall in a room with a high ceiling. Tape a tape measure to the wall. Stand back and observe how high the rockets travel upward along the wall. Let all students take turns measuring rocket altitudes
- What geometric shapes are present in a rocket?
- Use the discussion questions to design experiments with the rockets. Graph your results.



3-2-1 POP!

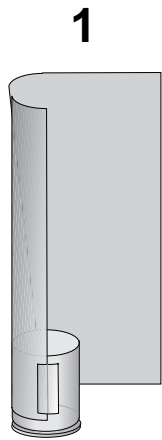

1
Wrap and tape a tube of paper around the film canister. The lid end of the canister goes down!

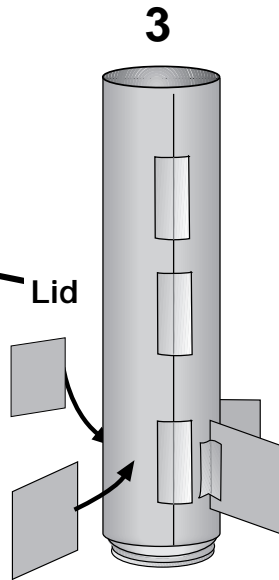
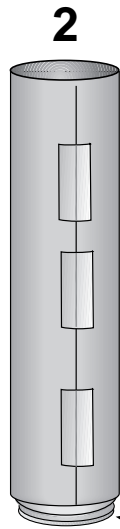

2
3
Tape fins to your rocket.

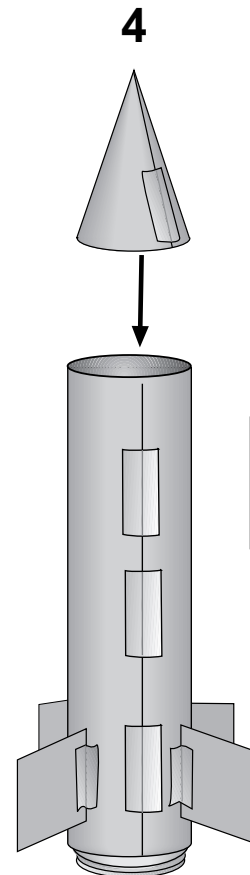

4
Roll a cone of paper and tape it to the rocket's upper end.

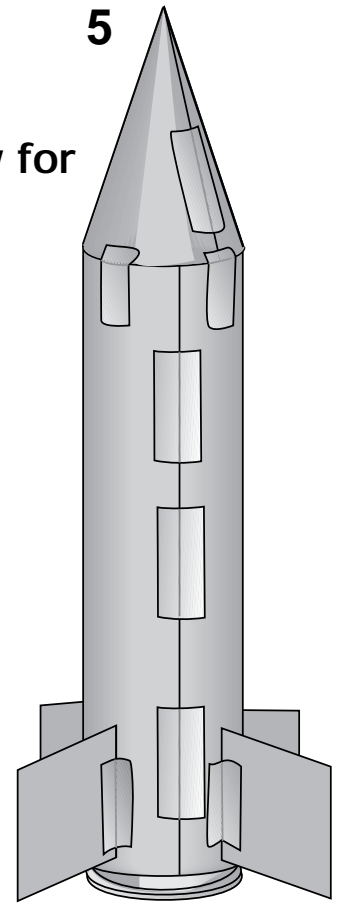

5
Ready for flight

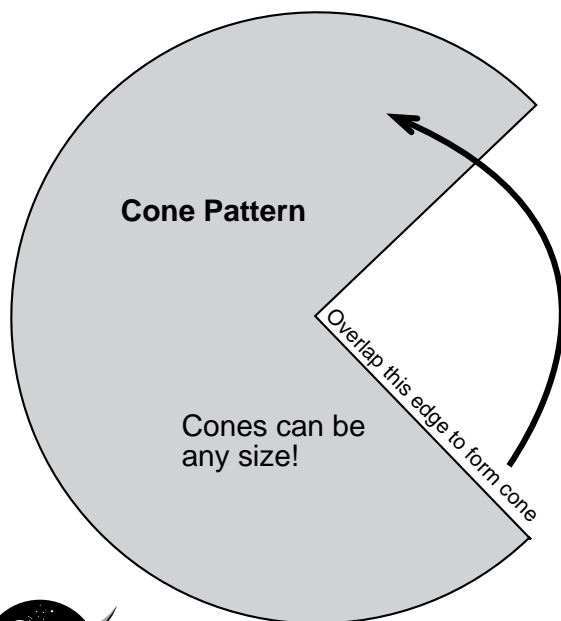

Cones can be any size!

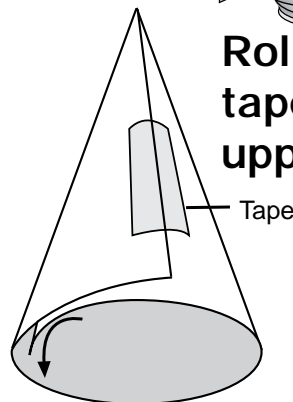

ROCKETEER NAMES

COUNTDOWN:

1. Put on your eye protection.
2. Turn the rocket upside down and fill the canister one-third full of water.

Work quickly on the next steps!

3. Drop in 1/2 tablet.
4. Snap lid on tight.
5. Stand rocket on launch platform.
6. Stand back.

LIFTOFF!

What three ways can you improve your rocket?

1. _____
2. _____
3. _____

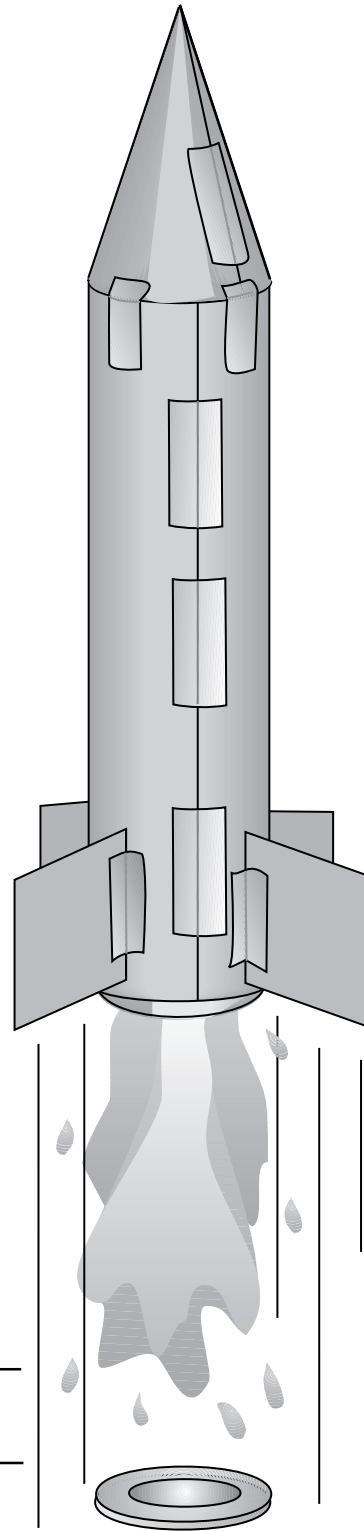



How Does the Alka Seltzer Rocket Work?



Alka Seltzer and water could not create a rocket explosion individually, but when they are mixed together the chemical reaction that is created is explosive!

Each **Alka Seltzer tablet expands in water** and releases a gas called carbon dioxide.



When the lid of the canister is put in place, the carbon dioxide is forced to stay in the canister's small space. **There is not enough space inside of the rocket's canister** for all of the carbon dioxide gas that is released.

When the rocket's canister cannot hold any more carbon dioxide, **the canister's lid will explode** off of the rocket, **pushing the rocket upward.**



***Newton's Third Law of Motion states,
"For every action there is an equal and opposite reaction."***

In this rocket launch, the build up of carbon dioxide gas (*the action*) forces the canister lid to release and propel the rocket into the air (*the reaction*).